



Security Products

NESS-M1 C-BUS Interface

INSTALLATION MANUAL

Version 3



IMPORTANT NOTICE: Every effort has been made to assure the accuracy of the information contained in this document as of the date printed. The extent of integration between the M1 System and C-BUS varies slightly depending where the interface is connected to the M1. Please refer to the manual for details.

GENERAL DESCRIPTION:

The Ness C-Bus Interface Module interfaces the Ness M1G and M1EZ8 to the Clipsal C-Bus networks. The Interface connects to the M1 via "PORT 0" (RS232 port) on the M1 panel, (or EZ8 / EZ24 panel) to "Com 2" of the M1 C-Bus interface. A second RS232 port ("Com 3") is used to connect to the M1's optional Ethernet module if required.

A third RS232 port ("Com 1") on the C-Bus interface board is used to connect to a PC to program some special option in the interface module as detailed later in this manual. (Please note a M1 - C-Bus utility program is required to program the interface module options)

Connection to the C-Bus network is done via the "Clipsal SIM" module onboard the interface and no other interface such as a C-Bus PCI is required.

As well as transmitting commands to the M1, it also has the ability to receive lighting commands from the C-Bus network which the M1 can be programmed to respond to.

The interface is a true plug and play interface with virtually no programming required to make it work. All lighting programming is done within the M1 via NessRP. The light No's 1-255 correspond to C-Bus Group addresses 1-255. (Note the M1 does not support C-Bus Group Address 0).

FEATURES:

- Fully approved C-Bus Enabled Product,
- Controls up to 255 individual C-Bus lights or outputs. (Includes full dimming, On / Off or toggle commands),
- True 2 ways communications on the C-Bus network,
- Connects directly onto C-Bus without the need for additional hardware such as a PCI Interface,
- Supports C-Bus Touch Screens and other C-Bus modules to control the M1 system,
- Any M1 event or status change can control modules on the C-Bus,
- Allows interfacing of M1 Ethernet module, Phone control or NessRM software to control C-Bus modules.
- Supports M1 Ethernet even when using M1 Port 0 communications for 2 way control.
- Allows C-Bus switches (keypads) to control M1 using Ness M1 rules engine

New enhanced features:

- Now Supports multiple C-bus applications,
- Now supports "Trigger Enable" and "Enable control", plus a lot more....

SPECIFICATIONS:

- Operating Voltage: 12 Volts D.C.
- Current Draw: Max 60 mA (Stand by 30 mA)
- Circuit Board Dimensions: 110mm x 115mm x 1.6mm



It is recommended that the C-Bus connection and configuration is performed by an installer who has attended a C-Bus Training course.



It is possible to configure the panel to send C-Bus commands each time a zone is unsealed (triggered), even when the system is disarmed.

Use this facility with caution - particularly with passive infrared detectors (PIR's) since the normal operation of some security devices may flood the C-Bus network with excessive communication. Everytime a selected PIR is triggered the M1 will put out a command on the C-Bus network via the C-Bus interface module.

Excessive C-Bus traffic will effect the performance of the C-Bus network. This does not completely negate this type of set-up, however it must be limited in its implementation.



PLEASE NOTE

This Ness M1 C-Bus interface will only work correctly with the M1 Firmware version 5.1.8 or later and NessRP Version 1.6.24 or later

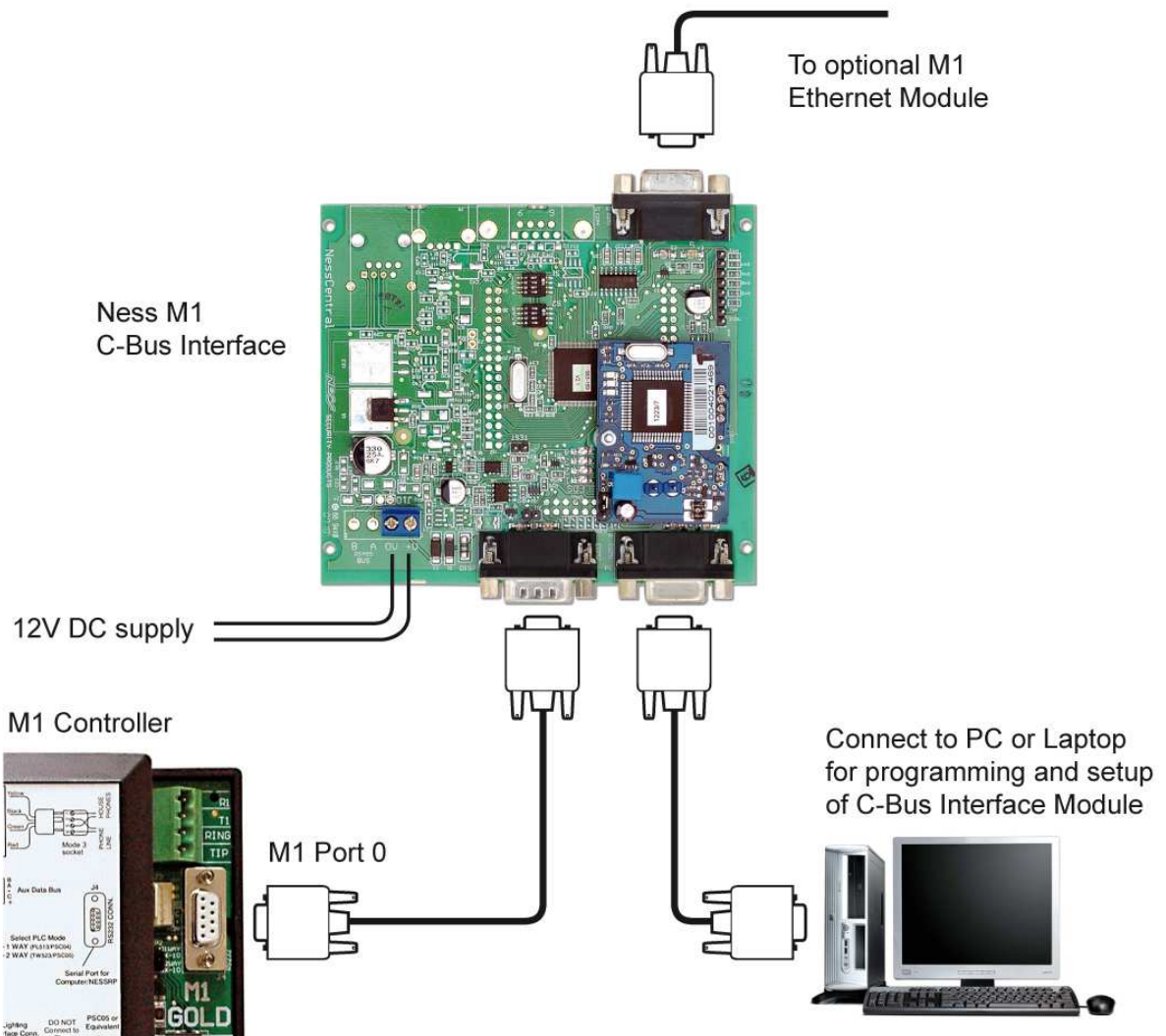

NESS C-BUS INTERFACE

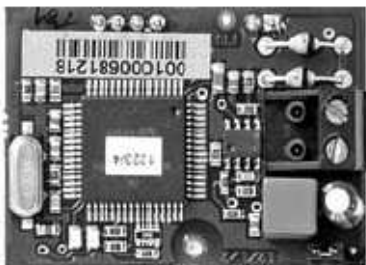

- C-Bus Positive (Blue + Orange)
- C-Bus Negative (Blue & White + Orange & White)
- NETWORK BURDEN JUMPER
This jumper is supplied in the OFF position and can be enabled if the C-Bus Network Burden is required. (Further information is available from Clipsal).

PROGRAMMING the M1 & TESTING

1. Program ALL "Group Address" in the M1 that you have on your C-Bus network as detailed below. (This is regardless of using the M1 to control the C-Bus Group Address / Light or not.)

Give all lights a name and set them all to "Serial Expander Format" **AND** set ALL lights to have the "Opt" box ticked. (Note: Failure to do this may cause lights being turned on and off at random).

If you do not want them to be controlled by the M1 then do not tick "show"



NOTE : To simplify M1 Panel Programming, NessRP has an import facility to import C-Bus light programming direct from "Tool Kit" using the C-Bus xml file. (As default in C-Bus toolkit at "C:\Clipsal\C-Gate2\tag\projectname.xml"). Right mouse click on M1 Lighting and select "Import Lighting Data" and follow the onscreen prompts.

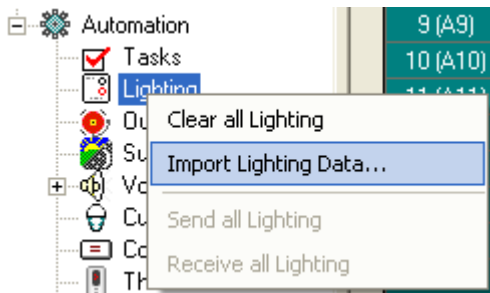

Import Lighting Data

ElkRP can import lighting data from select partner's exported data files. First, you must export the file from the partner's configuration software. Then choose the file format below, select the export file to be imported, and set the additional options as desired.

Export File Format

- Universal Devices ISY export for an Insteon network.
- UpStart export for a UPB network.
- C-Bus Toolkit XML project file.

Export/Project File

C:\Clipsal\C-Gate2\tag\NESS.xml

Handling of existing data

- Leave existing names, formats, and types as is, except replace (overwrite) those with matching addresses from the import file.
- Clear existing device names, formats, and types before importing.

Handling of the "Opt" flag

- Set (enable) the "Opt" flag for all devices imported.
- Leave the "Opt" flag as is for all devices.

Handling of the "Show" flag

- Leave the "Show" flag as is for all devices.
- Set (enable) the "Show" flag for all devices imported.

Handling of Voice Descriptions

- Leave "Voice Description" as is for all devices.
- Clear "Voice Description" for all devices imported.

2. Connect a 9-pin serial cable from the Ness M1 Port 0 to the Ness C-Bus Interface as shown on page 3.
(Ensure the baud rate is set to 115200 Baud in G34 option.)
3. Apply power to the C-Bus Interface.
4. Test the manual activation of any light by pressing the "ELK" key on the M1 Keypad followed by the Right arrow key to select "Menu 1-View/Control Automation Fncts.

Press 2 for the Lighting submenu, followed by the Right arrow key. The keypad will display the first Light name and number along with its On or Off status.



Note: The status may not be correct if the M1 had been powered off. To change the light from On to Off or from Off to On, press the # key. The light should then toggle On or Off.

4. Testing via M1 Rules;
Connect to the M1 using NessRP.
Click on the Rules icon in NessRP and create the following 2 test rules.

*Test Rule 1: WHENEVER 'Name' (Area 1) IS ARMED AWAY
THEN TURN 'Front Porch Light' [1 [A1]] ON*

*Test Rule 2: WHENEVER 'Name' (Area 1) IS DISARMED
THEN TURN 'Front Porch Light' [1 [A1]] OFF*

- 4b. Click "Send to Control" to transmit these rules to the M1.
- 4c. Disconnect NessRP from the M1.



Note: Communications is lost between the M1 and the C-Bus network when NessRP is connected to the M1 via "Port 0" of the M1. Therefore ensure you disconnect from the M1 (for at least 30 seconds) before attempting any tests.

The change of state of any C-Bus light will not be updated while while NessRP is connected to the M1 via "Port 0" (this includes connection via the Ethernet module)

Test the two automation rules by arming the control to the Away mode. The light should come On. Disarming the M1 should cause the light to turn Off.

4. This confirms the operation. Continue to test additional lights as required.
5. Other features that are available when using the 2 way operation, is to program rules so when a light / "Group Address" of C-Bus is activated it can control the M1. The following rule is an example of this function.

*Rule 1: WHENEVER 'Lighting 101' Turns On
THEN TURN "Garage Door ' [Output 9] ON*

*Rule 2: WHENEVER 'Lighting 101' Turns Off
THEN TURN 'Garage Door ' [Output 9] OFF*

(Note - When using this type of rule it is not recommended not to use a dim level to control the M1. Only use On or Off commands.

ADVANCED PROGRAMMING

Version 3 Interface module has a new enhanced programming feature that requires the use of the M1 - C-Bus interface utility program. This utility program allows the changing of C-Bus applications and the use of "Trigger Enable" commands among other features, as details below.

These enhanced features are programmed into the Interface module and not into the M1.

The Utility program connects via "Coms 1" of the interface module, which then does not require any other connection to be broke to connect.

Note: Communications is lost between the M1 and the C-Bus network (and between the M1 and the Ethernet module, if fitted) when the utility program connects to the interface module.

Ness M1 C-Bus Interface Utility Program

Note : This program is only required to be used to program Advanced Features, as detailed below, if required. Interfacing and operation between the M1 and the C-Bus network will still function as standard if no Advanced Feature programming is performed.

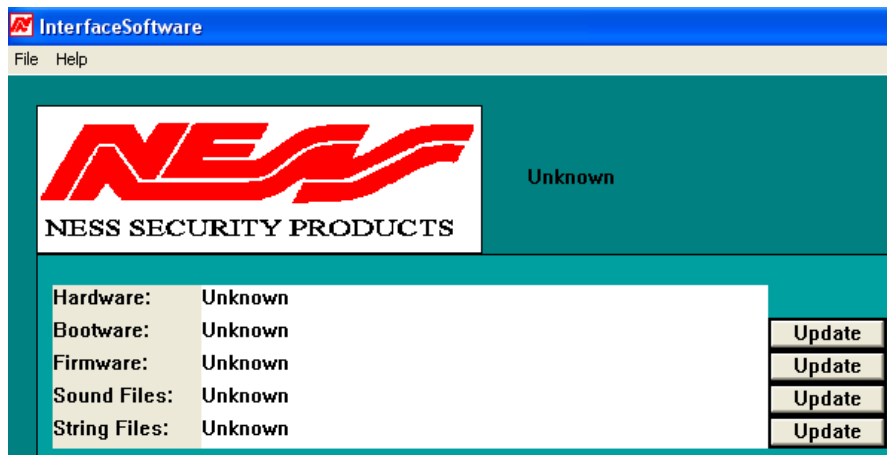

Once the utility program opens, if the RS232 cable is connected, it will attempt to connect to the Interface Module. (Note : If your PC does not have a RS232 port, you can use USB to RS232 leads such as the Ness 101-231 cable).

If it does not connect then click on "File / Change Port" , then select the serial comms port to be used on your PC.

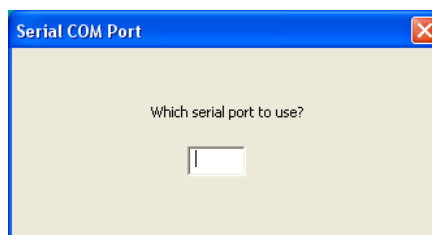
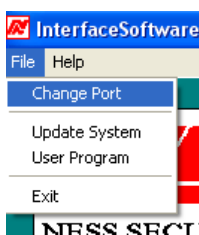

Leave the Baud rate, Data bits, Parity, Stop bits and flow control as per default and then click on OK.

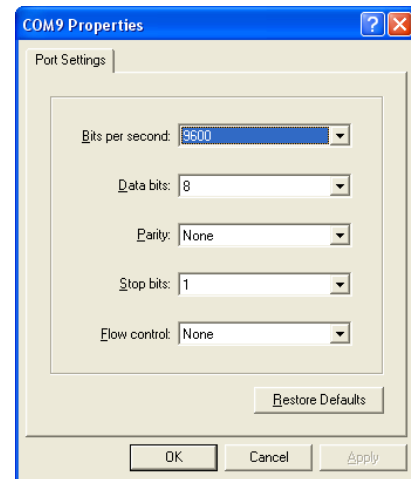

Once connected, the version number, firmware number and other details are displayed on the screen.

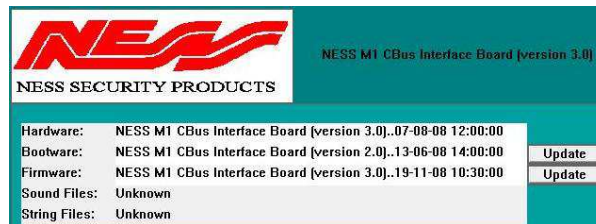

Advance programming

To access advanced programming click on "File / User Program".

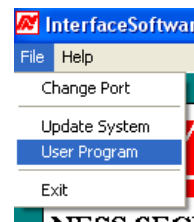

Advance programming

The first window when User Programming is accessed allows you to program the following.

1. CBus arm M1 Area

Within the C-Bus network, the C-Bus security feature allows you to arm one area of the security system. This first option allows you, if you are using this C-Bus feature, to select which of the 8 M1 Areas will be armed.

2.Password

As an M1 User Code is required to Arm the area, the Password section requires a valid M1 user code to be entered that will be sent off to the M1 when an arming request is made. If the user code is changed in the M1, then it will also need to be changed here.

3. Update CBus Time: When set to a time (e.g. 5 Hrs) then every 5 Hrs, the system will request the time and date from the M1 and then put this onto the C-Bus network to sync the C-bus devices with that of the M1.

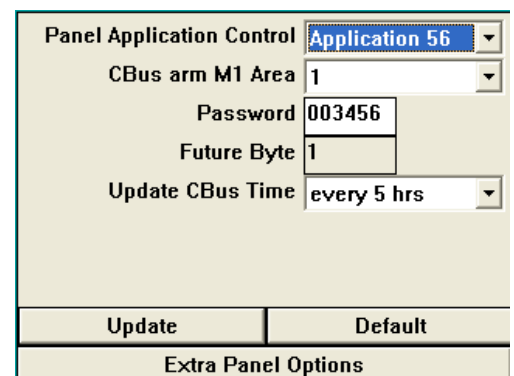

4. Panel Application control

As default the M1- C-Bus interface module has all "Group Address" set to Application 56 (Lighting). If required the Panel Application control programming option can change all M1 controlled Group Address from Lighting Application 56 to another application from Application 48-95.

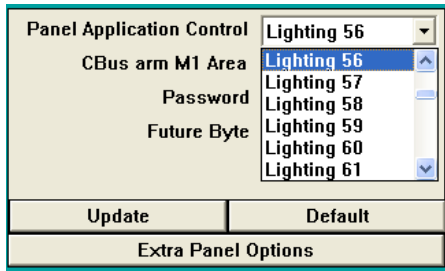

This can be a global change that effects all M1 to C-Bus Group address or it can be individual that allows setting different C-Bus Application for each of the M1 controlled Group Address.

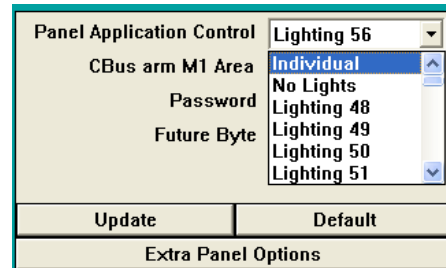

4b. Panel Application control - Individual Applications.

To bring up the options to be able to select individual C-Bus Group Address for each of the M1 Lights, select "Individual" under the Panel Application control.

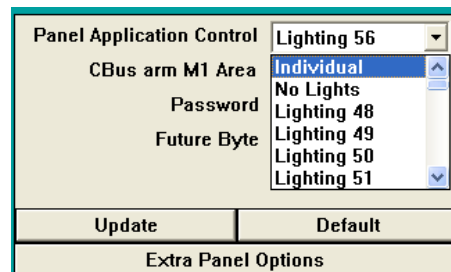

5C. Panel Application control - Individual Applications.

When Panel Application control - Individual is selected a list of all M1 Lights (1-254) will be visible on the right hand side of the screen.

	Channel
M1 Light 1 - CBus GA 1	Lighting 56
M1 Light 2 - CBus GA 2	Lighting 56
M1 Light 3 - CBus GA 3	Lighting 56
M1 Light 4 - CBus GA 4	Lighting 56

Scroll down to the M1 Light Number, which also corresponds to the corresponding C-Bus Group Address and change the individual Application to what you require to be sent to the C-Bus network on.

Note : As the M1 only supports 1 group of Lights / C-Bus Group Address 1-254 then once the "light" is used on one application it can't be used on another application.

	Channel	State
M1 Light 1 - CBus GA 1	Lighting 56	disable
M1 Light 2 - CBus GA 2	Lighting 56	disable
M1 Light 3 - CBus GA 3	Lighting 56	disable

4D. Light State

Enabled - the light command will only be sent to the CBus if the state is different then previously sent. The state is stored in the interface and upon a new light state from the panel it will transmit it to the CBus network. Therefore if "echoing" from the M1 occurs (which can happen for a number of reasons) the CBus interface will transmit it once only to prevent the C-Bus light / device from turning On / Off / On etc. (Note this feature is fixed on in the old version 2 and was previously removed in version 3. We have now reintroduced it but this this option that you now have the ability to turn it on and off for each Group address.)

- **Disabled** - transmits all lighting messages to the CBus network, regardless if the command had been sent or not.

5E. Block Time

	Channel	State	Block Time
M1 Light 1 - CBus GA 1	Lighting 56	disable	disable
M1 Light 2 - CBus GA 2	Lighting 56	disable	disable
M1 Light 3 - CBus GA 3	Lighting 56	disable	1 sec
M1 Light 4 - CBus GA 4	Lighting 56	disable	2 sec
M1 Light 5 - CBus GA 5	Lighting 56	disable	3 sec
			4 sec
			5 sec

This "Block Time" will stop any commands on that Group Address from being sent by the M1 for the period of time set in this option.

Set to "0" - (i.e.. disabled) The particular light will not block any commands and will transmit all light commands from the panel to the CBus network.

Set to "1"- "240" - blocks out panel light requests for the particular light for the duration programmed.

e.g.. programmed to 30 seconds.

(Time) 10:20:00 - light on....transmit to CBus network

(Time) 10:20:01 - light on....this is during block time so it is not transmitted to the CBus network

(Time) 10:20:20 - light off....this is during block time so it is not transmitted to the CBus network

(Time) 10:20:30 - light off.....transmit to CBus network as block time has ended.

"CHANGEALL"

If you wish to change all items in the column then 'mouse over' the heading and it will change to "Change All", click in it and then select what setting you wish all items in the column to be. Otherwise you can select each light / Group address individually.

	Channel	Change All	Block Time
M1 Light 1 - CBus GA 1	Application 56	enable	disable
M1 Light 2 - CBus GA 2	Application 56	enable	disable

Extra Panel Options

Within the Utility Program is the feature to add more enhanced programming to interface to C-Bus network and control C-Bus based on operation of the M1.

It uses a basic rules engine similar to the rules engine within the M1.

To access these Program Event option click on "Extra Panel Options".

Panel Application Control: Lighting 56
CBus arm M1 Area: 1
Password: 003456
Future Byte: 1
Update Default
Extra Panel Options

This then opens up 16 Program Event options where some logic rules can be programmed. To program these click on the "Program" button.

Program Event 1	Not programmed.	Program
Program Event 2	Not programmed.	Program
Program Event 3	Not programmed.	Program
Program Event 4	Not programmed.	Program
Program Event 5	Not programmed.	Program

This opens a Programming dialog where options can be programmed and stored in the Interface Module.

Program Lighting on Panel Events
Panel event to activate: [dropdown]
C-Bus Lighting Options
Application: [dropdown]
Network Bridges: [dropdown]
Group Address: [dropdown]
Function: [dropdown]
Value: 255
Update Delete Cancel

Using the drop down box will display a list of options that are available to be programmed in the Interface module.

These are independent to any rules that maybe programmed in the rules engine in the M1 panel.

The rules engine in the M1 itself gives a lot more options than these programmed in the interface module, however there are many instances where these are required, such as activating "Trigger Enable" applications.

Caution should be made when programming any rules in here as to not duplicate those programmed in the M1.

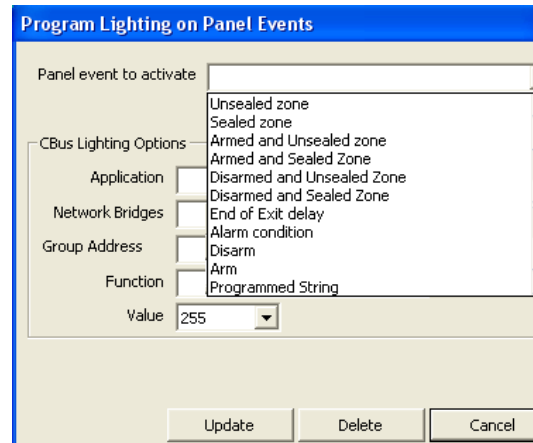

The following is a brief summary of each event.

Note: When an option is selected it will then add a secondary option associated to it.

Unsealed Zone : When an M1 Zone goes unsealed. (This is regardless of the Panel being armed or disarmed.) When selected it will bring up a secondary option to enable you to select what zone.

Sealed Zone : When a M1 Zone seals. When selected it will bring up a secondary option to enable you to select what zone.

Armed and Unsealed Zone : When the M1 is Armed and a zone is unsealed.

Armed and Sealed Zone : When the M1 is Armed and a zone is Sealed.

Disarmed and Unsealed Zone : When the M1 is disarmed and a zone is unsealed.

Disarmed and Sealed Zone : When the M1 is disarmed and a zone is Sealed.

End of Exit delay : When exit delay expires.

Alarm Condition : When an alarm from the M1 occurs.

Disarm : When the M1 Area is disarmed

Arm : When the M1 Areas is armed.

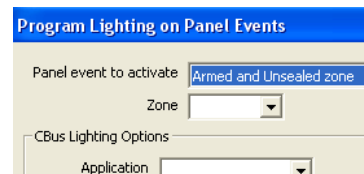
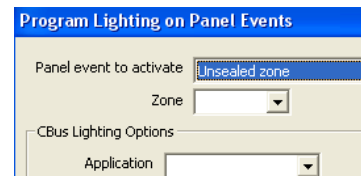

Programmed String : Refers to when a programmed Text String from an M1 is received.

Note : The area referred to in the above options is the area selected in the "C-Bus arm M1 Area" setting.

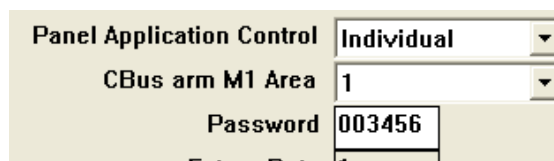

Anything programmed to "ARM" will occur when the Area is armed AND at the end of exit time.

In addition to the "Panel event to activate options, you also need to program "C-Bus options as summarized below.

Application : This allows you to select send "Trigger Control" and "Enable Control" commands to the C-Bus network.

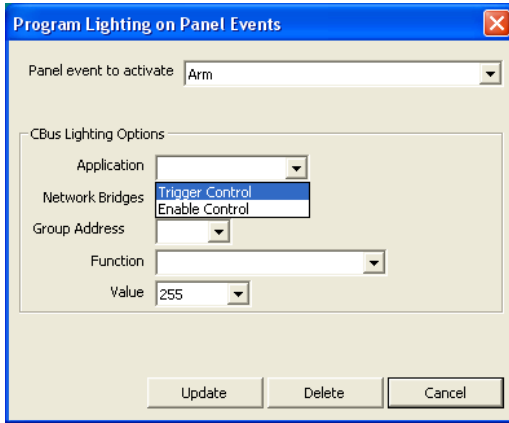
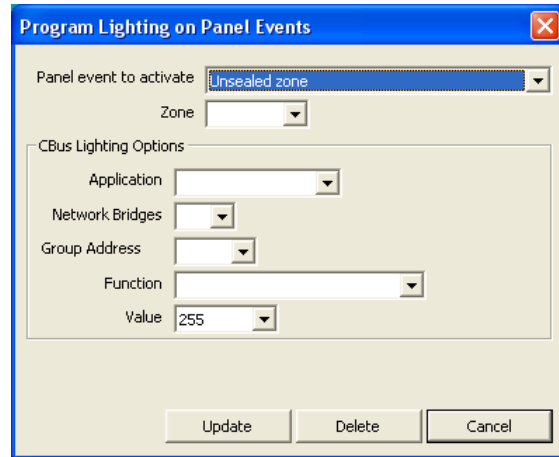

Network Bridges : This allows you to select if a Network bridge is used on your C-Bus network. If there is no network bridge used, then set this to "0".

Group Address : Sets what C-Bus "Trigger" Group Address the message will be sent to.

Function : Sets what function you wish to perform on the C-Bus network.

Value : Selects what "Trigger" group to activate.

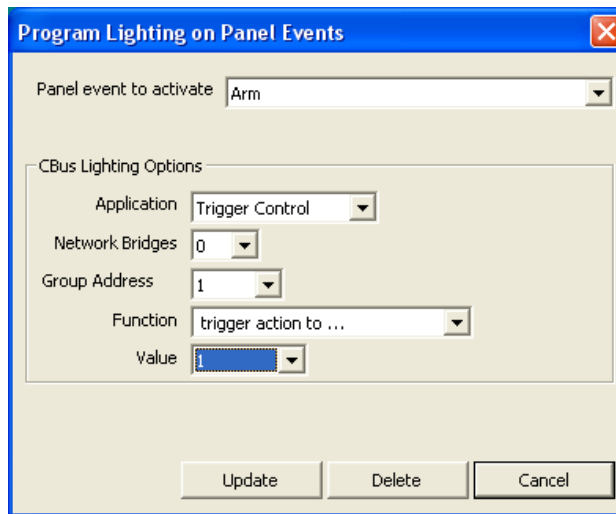

Once the programmed is saved in the interface module, and each time you connect using the utility software, all your programmed events will be displayed in the programmed event line. To modify these at anytime click on the "Program" button for the event you wish to modify.



Head Office: Ness Security Products- 4/167 Prospect Hwy, Seven Hills NSW,
Australia

Phone +61 2 8825 9222
email : ness@ness.com.au

Sydney Office - (02) 8825 9222
Melbourne Office -(03) 9875 6400
Brisbane Office - (07) 3399 4910
Perth Office -(08) 9328 2511
Adelaide Office - (08) 8277 7255

m1support@ness.com.au

Document Part No. 890-393